

# Raritan AMS Series Intelligent Electronic Asset Management

## Quick Setup Guide

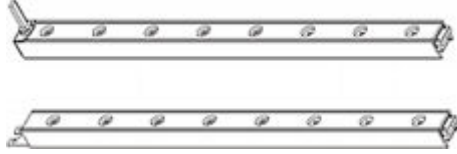

**AMS models and model series (# = number of tag ports): AMS-M#, AMS-S#, AMS-E#, AMS-B#, AMS-B#P, AMS-#, AMS2-M, AMS2-S, AMS2-E#.**

Thank you for purchasing Raritan AMS asset management strips. This asset management solution helps you track the locations of IT devices in the data center and server room. This Quick Setup Guide explains how to install and configure asset strips.

### An Overview of the Asset Management Solution

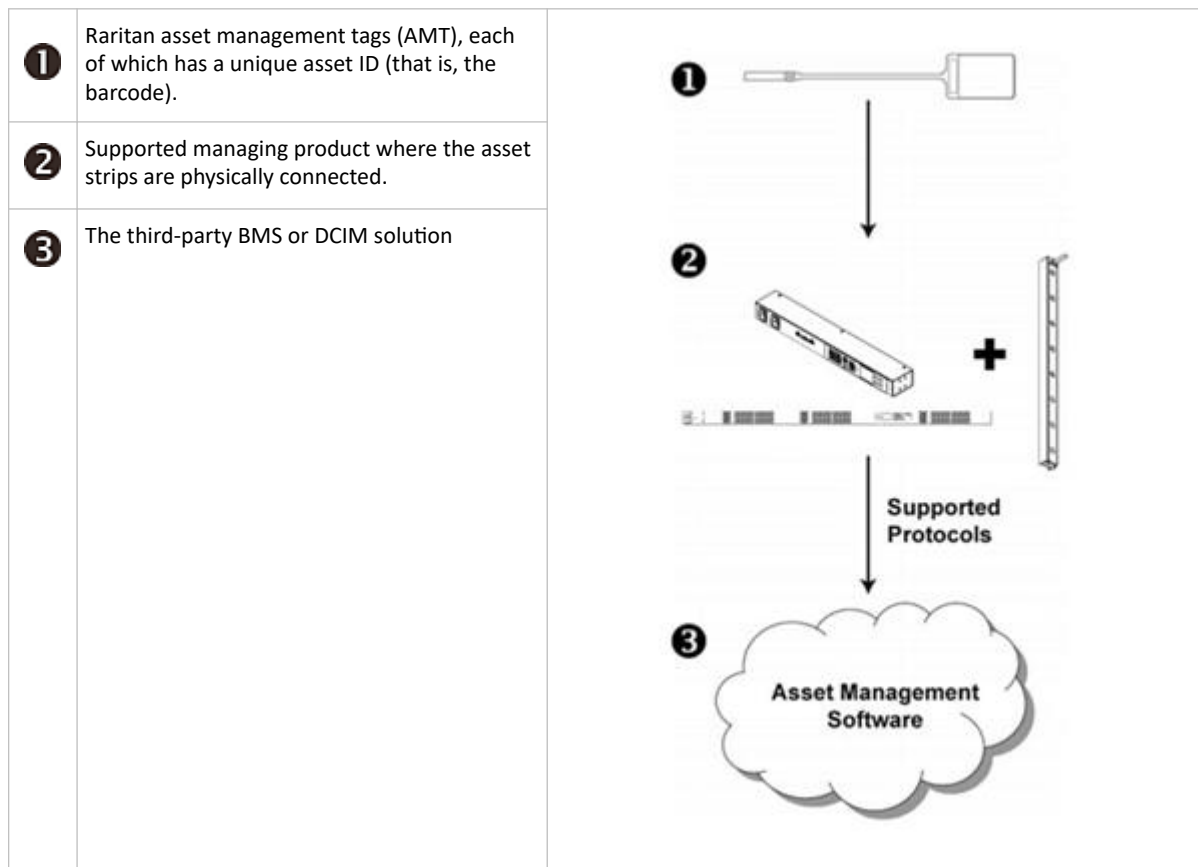

A third-party asset management software can access asset strips via supported protocols, such as SNMP, JSON-RPC, HTTPS or command line interface.

## Supported Managing Devices

Asset management can be used with the following supported managing devices. AMS and AMS2 cannot be combined on the same managing device.

Asset Management Strip (AMS)		Asset Management Strip-2 (AMS2)	
Connection via Feature Port only		Connection via Sensor Port only	
Smart Rack Controller	• v3.5.10 or later	PX4 PDUs	• v4.0.40 or later
PX2 PDUs	• v2.2.0 or later	PRO4X PDUs	
PX3 PDUs	• v2.5.20 or later	Smart Rack Controller 0800	
PX3TS transfer switches	• v2.6.0 or later	PX3 PDUs	
BCM2 and PMC	• All versions	PX3TS transfer switches	
		PMMC and PMC	
		PRO3X	

## Combining Asset Strips

Each tag port on the regular asset strips corresponds to a rack unit and can be used to locate IT devices in a specific rack (or cabinet). For each rack, you can attach asset strips up to 64U long, consisting of one PRIMARY and multiple EXPANSION asset strips.

The difference between the primary and expansion asset strips is that the primary asset strip has an RJ-45 connector while the expansion does not.

Examples: Not all available types are pictured.

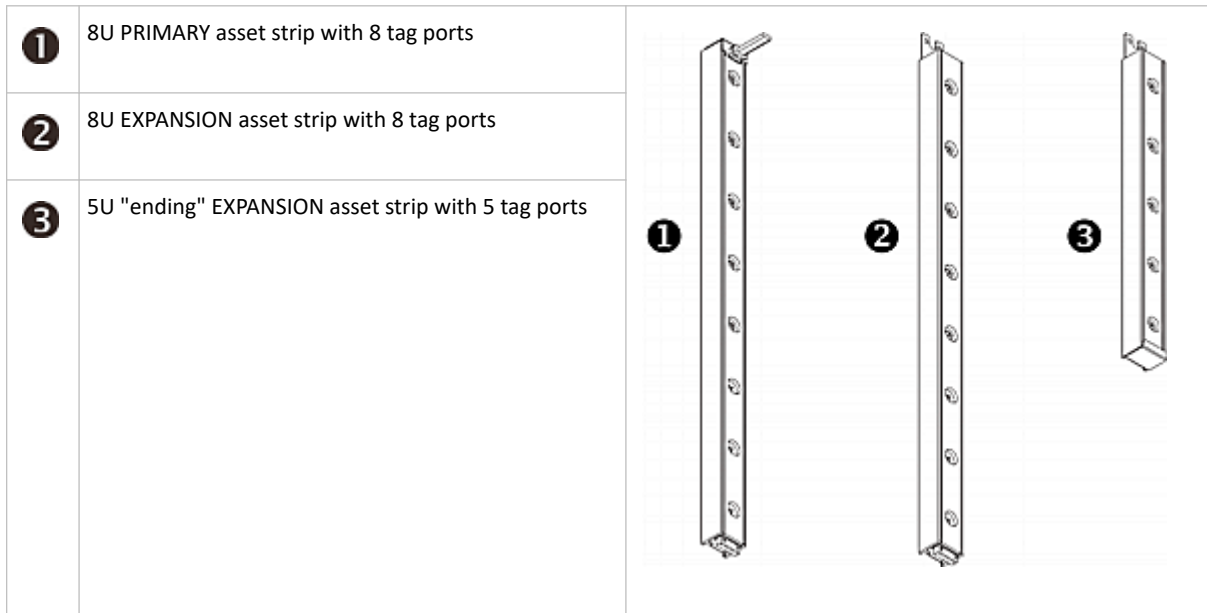

Note: Unlike general EXPANSION asset strips, which have one DIN connector respectively on either end, the ending EXPANSION asset strip has one DIN connector on only one end. An ending asset strip is installed at the end of the asset strip assembly.

► *To assemble asset strips:*

1. Connect a PRIMARY asset strip to a EXPANSION asset strip.
  - Plug the white DIN connector of the expansion strip into the white slot DIN socket of the primary strip.
  - Make sure that the U-shaped sheet metal adjacent to the DIN connector is inserted into the rear slot of the primary strip. Screw up the U-shaped sheet metal to reinforce the connection.

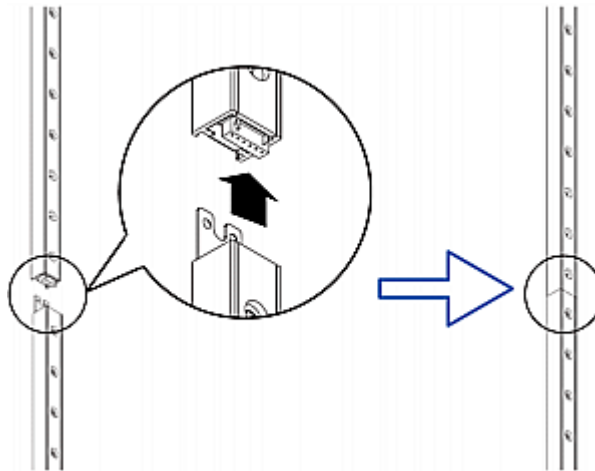

2. Connect another expansion strip to the one being attached to the primary strip in the same manner as Step 1.
3. Repeat the above step to connect more expansion strips.
  - The length of the asset strip assembly can be up to 64U with a maximum of 8 strips in a chain. Note that AMS-48U counts as 6 strips.
  - The final expansion strip can be any length, depending on the actual height of your rack.
  - Connect the "ending" asset strip as the final one in the assembly.
4. Vertically attach the asset strip assembly to the rack, next to the IT equipment, making each tag port horizontally align with a rack unit.
5. The asset strips are automatically attracted to the rack because of magnetic stripes on the back.

Note: The asset strip is implemented with a tilt sensor so it can be mounted upside down.

## Connecting Asset Strips and Tags

There are two series of asset strips: AMS and AMS2.

AMS series connects with the FEATURE port of the managing device, whereas AMS2 series connects with the SENSOR port. Only 1 asset strip is supported for each managing device. You cannot mix AMS and AMS2 series asset strips.

AMS2 series has two RJ45 ports. The second port can be used to attach peripheral sensors, but due to power limitations, AMS2 can only support a few temperature/humidity sensors, such as DX2-T1H1. Power consuming peripheral devices such as DX2-DH2C2, DX-PD2C5/DX2-PD2C5 are not supported with AMS2. AMS2 can only be connected directly to the supported managing device's SENSOR port--mixed use with DX2-ENVHUB4 or any other sensor hub is not supported.

You need both asset strips and asset tags for tracking IT devices. Asset tags provide an ID number for each IT device. The asset tags are adhered to an IT device at one end and plugged in to an asset strip at the other.

The asset strip is connected to the managing device, and the asset tag transmits the ID to the asset strip. Positioning information is also shared from the connected port.

There are two types of asset tags: non-programmable and programmable tags. Programmable asset tags allow you to customize each tag's ID or barcode number. Non-programmable tags have factory default ID or barcode numbers, which you cannot change.

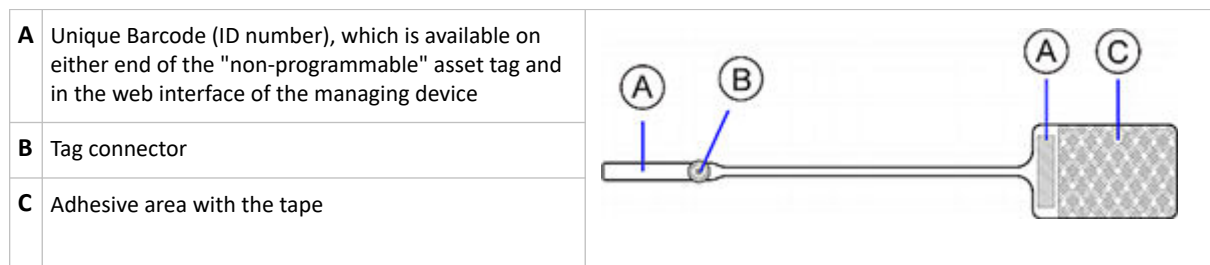

► *To connect asset strips to the managing device:*

1. Affix the adhesive end of an asset tag to each IT device through the tag's tape.
2. Plug the connector of each asset tag into the corresponding tag port on the asset strip.
3. Connect the asset strip assembly to the managing device, using a network patch cable (CAT5e or higher).
  - a. Connect one end of the cable to the RJ-45 connector on the PRIMARY asset strip.
  - b. Connect the other end of the cable to the FEATURE port for AMS or to the SENSOR port for AMS2 on the managing device.

The managing device supplies power to the connected asset strip assembly. All LEDs on the asset strip assembly may cycle through different colors during the power-on process if the asset strip's firmware is being upgraded by the managing device. After the power-on or firmware upgrade process completes, the LEDs show solid colors. Note that the LED color of the tag ports with asset tags connected will be different from the LED color of the tag ports without asset tags connected. LED colors can be configured in the web interface.

<b>A</b>	Managing device
<b>B</b>	Asset strips
<b>C</b>	Asset tags
<b>D</b>	IT equipment, such as servers

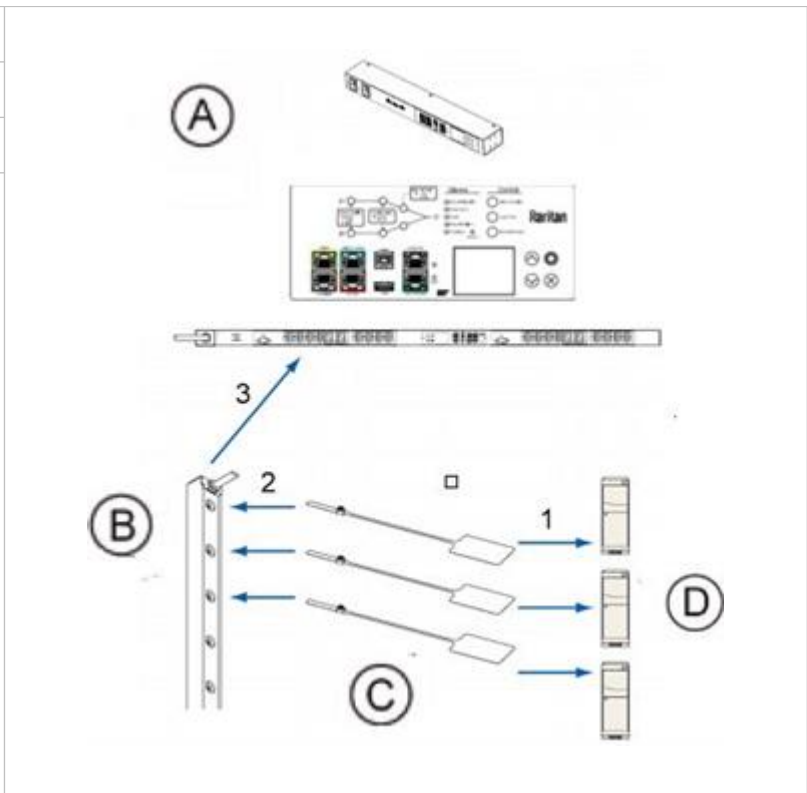

### Connecting Blade Extension Strips

For blade servers, which are contained in a single chassis, you can use a blade extension strip to track individual blade servers.

Raritan's blade extension strip functions similarly to a Raritan asset strip but requires a tag connector cable for connecting it to a tag port on the asset strip. One asset strip can manage 64 tags on the main strip plus 128 tags on blade extensions.

The following diagrams illustrate a tag connector cable and a blade extension strip with 16 tag ports.

#### Tag connector cable

<b>A</b>	Barcode for the tag connector cable	
<b>B</b>	Tag connector	
<b>C</b>	Cable connector for connecting the blade extension strip	

**Blade extension strip with 16 tag ports**

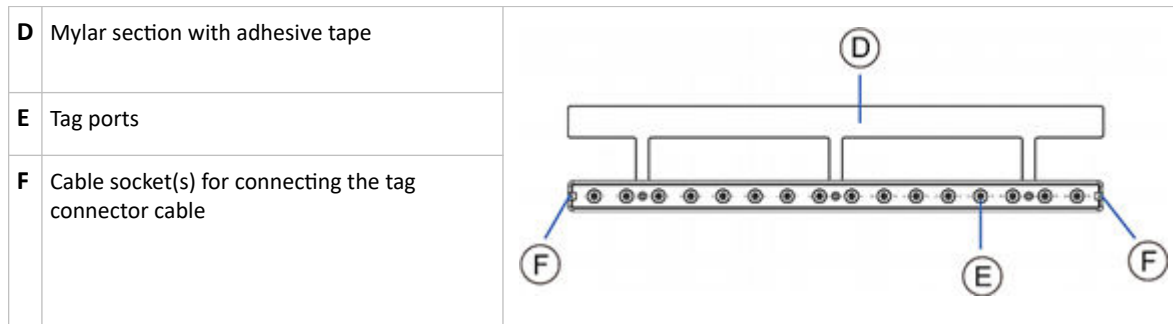

Note: Each tag port on the blade extension strip is labeled a number, which is displayed as the slot number in the managing device's web interface.

► *To install a blade extension strip:*

1. Connect the tag connector cable to the blade extension strip.
  - Plug the cable's connector into the socket at either end of the blade extension strip.

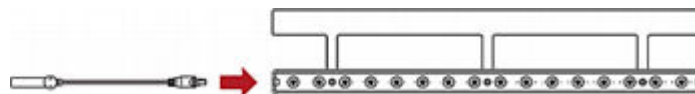

2. Move the blade extension strip toward the bottom of the blade chassis until its mylar section is fully under the chassis, and verify that the blade extension strip does not fall off easily. If necessary, you may use the adhesive tape in the back of the mylar section to help fix the strip in place.

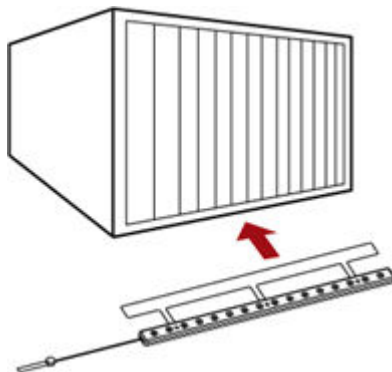

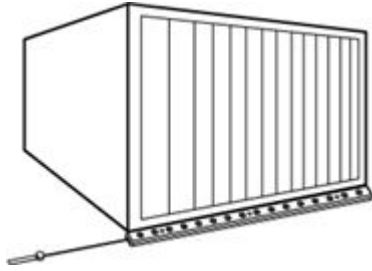

3. Connect one end of an asset tag to a blade server and the other end to the blade extension strip.
  - a. Affix the adhesive part of the asset tag to one side of a blade server through the tag's tape.
  - b. Plug the tag connector of the asset tag into a tag port on the blade extension strip.

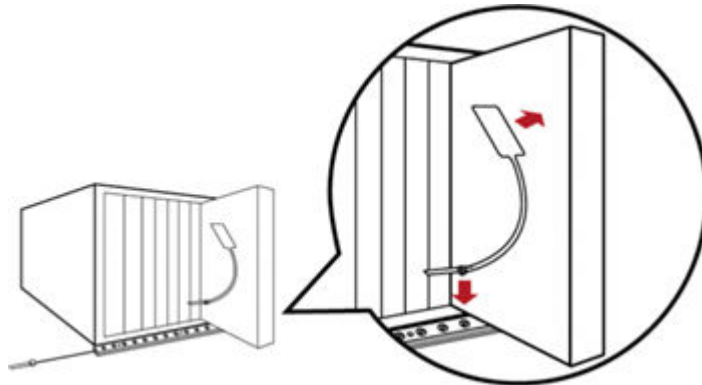

4. Repeat the above step until all blade servers in the chassis are connected to the blade extension strip via asset tags.
5. Plug the tag connector of the blade extension strip into the closest tag port of the asset strip on the rack.

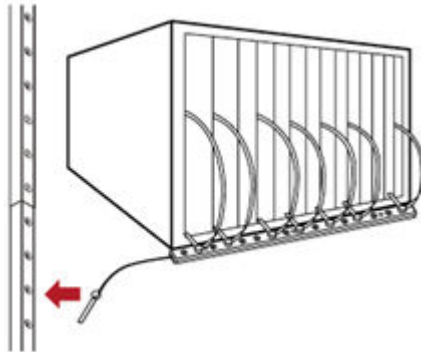

### What to Do Next

Your managing device will detect the attached asset strip. In the web interface, go to the Asset Strip option in the Menu. Administrators can configure the name, number of rack units, numbering mode, numbering offset, orientation and the color with or without connected tags.

Each rack unit can be set individually. Name, operation mode, LED mode and color of each unit can be customized.

Rack Units								Program Asset IDs
Rack unit ▲	Index	Slot	Name	Asset / ID	Operation Mode	LED Mode	LED Color	
1	1				Manual override	On		
2	2				Auto (based on tag)	On		
3	3				Auto (based on tag)	On		
4	4				Auto (based on tag)	On		
5	5				Auto (based on tag)	On		

## Additional Information

For more information about and the entire Raritan product line, see Raritan's website ([www.raritan.com](http://www.raritan.com)). For technical issues, contact Raritan Technical Support. See the Contact Support page in the Support section on Raritan's website for technical support contact information worldwide. Raritan's products use code licensed under the GPL and LGPL. You can request a copy of the open source code. For details, see the Open Source Software Statement at (<https://www.raritan.com/about/legal-statements/open-source-software-statement/>) on Raritan's website.

### FCC

This device complies with Part 15 Class A of the FCC Rules. Operation is subject to the following two conditions:

- This device may not cause harmful interference, and
- This device must accept interference received, including interference that may cause undesired operation.

### VCCI

この装置は、クラスA情報技術装置です。この装置を家庭環境で使用すると電波妨害を引き起こすことがあります。この場合には使用者が適切な対策を講ずるよう要求されることがあります。 VCCI-A

### Canadian ICES-003

CAN ICES-3 (A) / NMB-3 (A)