



## Raritan PX2 and PX3

Thank you for purchasing the Raritan intelligent power distribution unit (PDU) -- PX2 or PX3.

The intended use of PX2/PX3 is distribution of power to IT equipment such as computers and communication equipment, typically mounted in a rack located in a data center/equipment room.

This Quick Setup Guide explains how to install and configure the PX2/PX3. For more, access online help from the web interface or go to Raritan's **Support page** ([www.raritan.com/support](http://www.raritan.com/support)).

### Safety Precautions

**WARNING!** Before installing or operating this product, read and understand all sections in this guide. Failure to heed any of the following WARNINGS may result in electric shock, fire, personal injury and death. Prior to operating this product, the user should read the online help and specifically the warnings in the online help.

**WARNING!** Connect this product to an AC power source with a voltage that is within the range specified on the product's nameplate.

**WARNING!** Connect this product to an AC power source that is current limited by a suitably rated fuse or circuit breaker in accordance with national and local electrical codes.

**WARNING!** Use this product in a dry location.

**WARNING!** Connect this product to a protective earth ground. Never use a "ground lift adaptor" between the product's plug and the wall receptacle.

**WARNING!** If this product is a model that requires the assembly of the line cord or plug, the assembly must be performed by a licensed electrician, and the line cord or plugs used must be rated based on the product's nameplate ratings, as well as national and local electrical codes.

---

### Unpacking the PX2/PX3

PX2/PX3 comes in Zero U, 1U, and 2U sizes. The following describes the equipment shipped with each size.

If any pieces are missing or damaged, report this to Raritan Technical Support, or contact the Raritan partner where you purchased the product.

#### Zero U Size

- PX2 or PX3 PDU
- Mounting screws, brackets and/or buttons
- Cable retention clips for the inlet and/or outlets (for some models only)

#### 1U and 2U Size

- PX2 or PX3 PDU
- 1U or 2U bracket pack and screws
- Cable retention clips for the inlet (for some models only)

---

**Note:** An "optional" null-modem cable with DB9 connectors on both ends (Raritan number: 254-01-0006-00) for PX2 may be available per request. For PX3, use a third party RJ45-to-DB9 adapter/cable instead of a null-modem cable.

---

## Before You Begin

1. Prepare the installation site. Make sure the installation area is clean and not exposed to extreme temperatures or humidity. Allow sufficient space around the device for cabling and outlet connections. Safety instructions are provided in the PX2/PX3 online help.

Fill out the Equipment Setup Worksheet found in the online help. Record the model, serial number, and use of each IT device connected to the PDU's power outlets.

---

## Mounting the PDU

Use one of the mounting methods to install your product.

### Circuit Breaker Orientation Limitation

Usually a PDU can be mounted in any orientation. However, when mounting a PDU with circuit breakers, you must follow these rules:

- Circuit breakers CANNOT face down. For example, do not horizontally mount a Zero U PDU with circuit breakers facing up or down.

### Mounting 1U or 2U Models

Using the appropriate brackets and tools, fasten the 1U or 2U device to the rack or cabinet.

▶ **To mount the PX2/PX3 device:**

1. Attach a rackmount bracket to both sides of the PX2/PX3 with the provided screws.

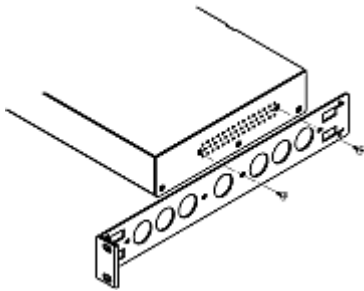

2. Insert the cable-support bar into rackmount brackets.

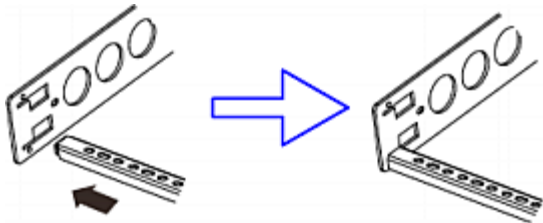

3. Secure with the provided end cap screws.

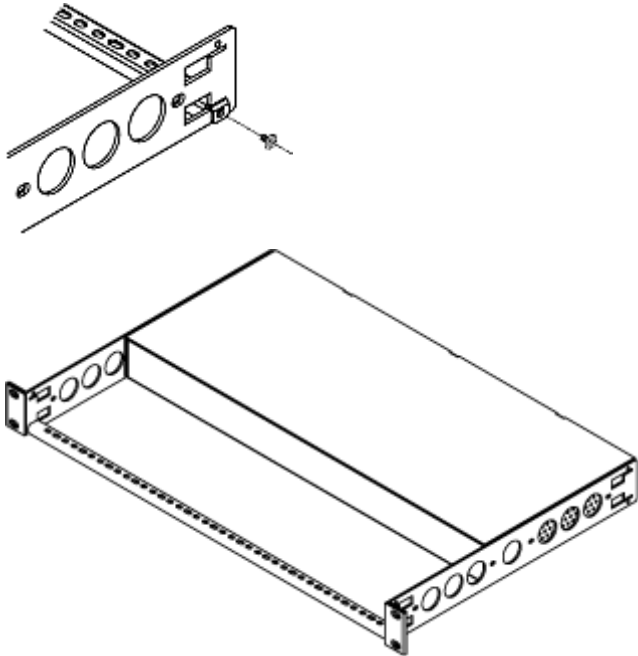

4. Fasten the rackmount brackets' ears to the rack using your own fasteners.

### Mounting Zero U Models Using Baseplate-Based Tools

You can use one of the three baseplate-based tools to mount the PDU: L-brackets, buttons or claw-foot brackets.

► **To mount Zero U models using baseplates:**

1. Align the baseplates on the rear of the PX2/PX3 device.
2. Make the baseplates grasp the device lightly. Use the included L-shaped hex key to loosen the hex socket screws until the baseplate is "slightly" fastened.

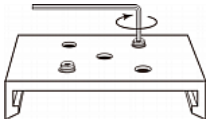

3. Attach brackets or buttons to the baseplates.

- Fasten each L-bracket or claw-foot bracket to each baseplate with at least three screws (one through each slot).

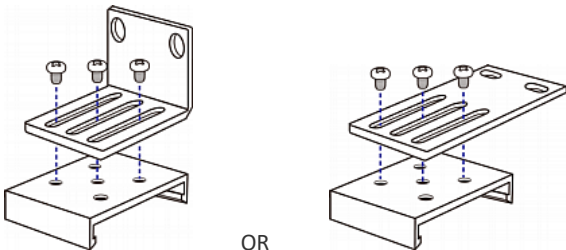

- Screw each mounting button to each baseplate. The recommended torque for the button is 1.96 N·m (20 kgf·cm).

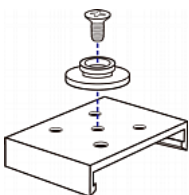

4. Fasten the device to the rack or cabinet using the baseplate-based tools.
  - Use rack screws to fasten L-brackets or claw-foot brackets on the PDU to the rack.
  - For the buttons, press the PDU forward, pushing the mounting buttons through the mounting holes, then letting the device drop about 5/8".

## Mounting Zero U Models Using Buttons

1. Turn to the rear of the PX2/PX3.
2. Locate the two screw holes on the rear panel.
3. Screw a button in each screw hole. The recommended torque for the button is 1.96 N·m (20 kgf·cm).

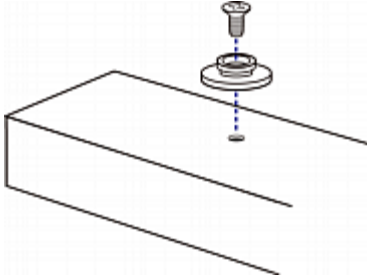

4. Press the PDU forward, pushing the mounting buttons through the mounting holes, then letting the PDU drop slightly.

## Mounting Zero U Models Using L-Brackets and Buttons

1. Fasten the L-bracket to each end of the PDU.

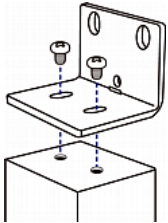

2. Choose either of the following ways to fasten the PDU to the rack.
  - Attach the rack screws to the two rackmount holes of each L-bracket.
  - Screw a mounting button in the back center of each L-bracket and then have both buttons engage the mounting holes in the rack. The recommended torque for the button is 1.96 N·m (20 kgf·cm).

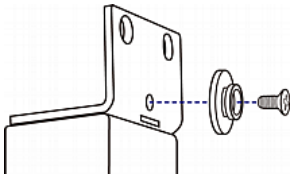

---

## Connecting the PX3 Locking Line Cord

A PX3 model is shipped with a locking line cord. Plug that cord into the PDU's inlet and the cord is securely locked.

**Note:** To remove the cord, press the locking clips or push the slide buttons at two sides of the cord's connector.

---

---

## Connecting the PDU to a Power Source

Do not stretch the power cord.

► **To connect a PDU to the power source:**

1. Verify that all circuit breakers on the PX2/PX3 are set to ON. If not, turn them ON.  
Or make sure that all fuses are inserted and seated properly. If there are any fuse covers, ensure that they are closed.

---

Note: Not all models have overcurrent protectors.

---

2. Connect each PX2/PX3 to an appropriately rated branch circuit. Refer to the label or nameplate affixed to your PX2/PX3 for appropriate input ratings or range of ratings.
  3. When a PX2/PX3 powers up, it proceeds with the power-on self test and software loading for a few moments. At this time, the outlet LEDs cycle through different colors.
- 

Note: If a PDU beeps after being powered up, either its circuit breaker has tripped or the L-N wiring is reversed. If no circuit breakers tripped, check the wiring of the plug adapter that is used or the direction in which the plug or plug adapter is plugged into the power socket.

---

4. When the software has completed loading, the outlet LEDs show a steady color and the front panel display illuminates.
- 

## Connecting the PDU to Your Network

PX2/PX3 can be connected to a wired or wireless network.

### ▶ To make a wired connection:

1. Connect a standard network patch cable to the Ethernet port on the PX2/PX3.
  2. Connect the other end of the cable to your LAN.
- 

Note: The "green" Ethernet port labeled "ETH①10/100/1000" supports up to 1000 Mbps so it is highly recommended for network connection.

---

### ▶ To make a wireless connection:

1. Connect an appropriate USB wireless LAN adapter to the PX2/PX3.
  2. Make sure the wireless LAN configuration is supported by your PX2/PX3. See Wireless LAN Information.
- 

## Initial Network Configuration

Depending on your networking environment, the best method to initially configure your PX2/PX3 differs.

- For a DHCP IPv4 networking environment, see **Using a Web Browser** (on page 5).
  - For an IPv6 or "static" IPv4 networking environment, see **Appendix A: Configuration via a Mobile Device or PDView** (on page 6).
- 

## Using a Web Browser

### Step 1: Retrieve the IP Address

After connecting to a DHCP IPv4 network, an IPv4 address is automatically assigned to your PX2/PX3.

PX2's IP address is available by connecting an iOS or Android mobile device to PX2.







PX3's IP address is available using the front panel display.

### PX2 Models

1. Download Raritan's app, *PDView*, to your mobile device.
2. Connect the mobile device to the PDU USB port -- *iOS* via USB-A, or *Android* via USB-B.
3. Launch *PDView* to access the web interface.
4. Choose Maintenance > Device Information. Click 'Network' to check the IP address.

### PX3 Models

#### ▶ To retrieve the IP address:

1. Press  or  to show the "Main Menu."
2. Press  or  to select "Device Info," and press .
3. Press  or  until the device's IP address is displayed.

## Step 2: Log in to the PX2/PX3 Web Interface

1. In a web browser, enter the PDU IP address and login with the default user credentials, accepting any security warnings.
  - Default login: admin/raritan

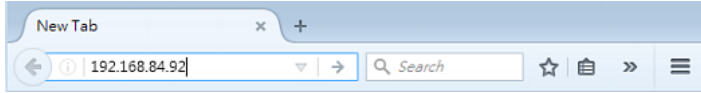

Password change is enforced at first login.

---

## Appendix A: Configuration via a Mobile Device or PDView

An iOS or Android mobile device, such as a smartphone or tablet, can function as a local display. Android devices must support USB "On-The-Go" (OTG).

### Step 1: Download the "PDView" App

Raritan's free app "PDView" is required for the mobile device to function as a local display.

#### ► To download PDView:

1. Visit either Apple App or Google Play Store.
  - <https://itunes.apple.com/app/raritan-pdview/id780382738>



- <https://play.google.com/store/apps/details?id=com.raritan.android.pdview>



2. Install PDView.



### Step 2: Connect the Mobile Device to PX2/PX3

The USB cable and USB port to connect are determined by your mobile operating system.

#### ► To connect your mobile device to PX2/PX3:

1. Get an appropriate USB cable for your mobile device.
  - *iOS*: Use the regular USB cable shipped with your iOS mobile device.
  - *Android*: Use an **USB OTG** adapter cable.
2. Connect the mobile device to the appropriate USB port on the product.
  - *iOS*: USB-A port.

- *Android:* USB-B port

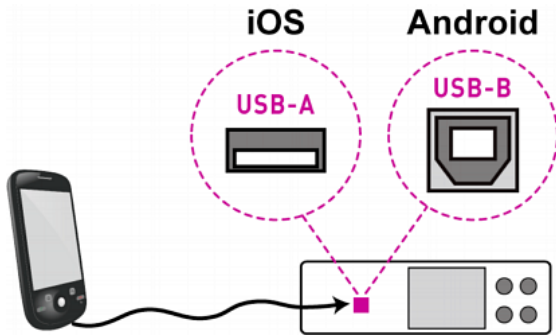

### Step 3: Launch PDView

► **To access the PX2/PX3 web interface:**

1. Launch PDView on your mobile device.
2. Wait until PDView detects the connected PX2/PX3 and shows the word "Connected" in green.

### Connected

3. If the factory-default login credentials remain unchanged, or if PDView has been configured with accurate login credentials, PDView automatically logs in to the web interface of PX2/PX3.  
If PDView can't login automatically, the login screen displays instead and you must enter appropriate user credentials for login.
4. For initial login, you are prompted to change the password.

## Appendix B: Wireless Configuration

► **USB Wireless LAN Adapters**

The PX2/PX3 supports the following USB Wi-Fi LAN adapters.

Wi-Fi LAN adapters	Supported 802.11 protocols
SparkLAN WUBR-508N	A/B/G/N
Proxim Orinoco 8494	A/B/G
Zyxel NWD271N	B/G
Edimax EW-7722UnD	A/B/G/N
TP-Link TL-WDN3200 v1	A/B/G/N
Raritan USB WIFI	A/B/G/N

► **Supported Wireless LAN Configuration**

If wireless networking is preferred, ensure that the wireless LAN configuration of your PX2/PX3 matches the access point.

- Network type: 802.11 a/b/g/n.
- Protocol: WPA2 (RSN).
- Key management: WPA-PSK, WPA-EAP with PEAP and MSCHAPv2 authentication, WPA-EAP with TLS authentication, or WPA-EAP with PEAP and TLS authentication.
- Encryption: CCMP (AES)

**Tip: Supported 802.11 network protocols vary according to the wireless LAN adapter being used.**

► **Making a Wireless Connection**

- Plug a supported USB wireless LAN adapter into the USB-A port on your PX2/PX3.

OR

- Connect a USB hub to the USB-A port on the PX2/PX3. Then plug the supported USB wireless LAN adapter into the appropriate USB port on the hub.

---

## Appendix D: More Information

### Identifying the Sensor Port

Warning: Only connect environmental sensors to the SENSOR port, or damages may be caused to the device and the sensor packages.

- The correct port is labeled SENSOR and highlighted yellow.

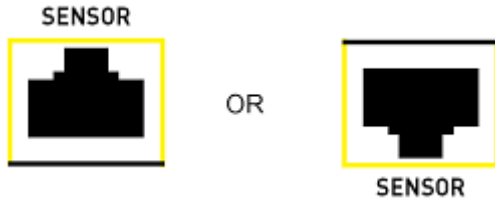

---

Note: On a PX2 PDU, there is no yellow color shown on the SENSOR port.

---

### Threaded Grounding Point

Some models have a threaded grounding point. Identify it via the grounding symbol:



Wire this point to an electrical system to protectively ground the PDU.

### Additional Information

For more information about PX2/PX3 and the entire Raritan product line, see Raritan's website ([www.raritan.com](http://www.raritan.com)). For technical issues, contact Raritan Technical Support. See the Contact Support page in the Support section on Raritan's website for technical support contact information worldwide.

Raritan's products use code licensed under the GPL and LGPL. You can request a copy of the open source code. For details, see the Open Source Software Statement at (<https://www.raritan.com/about/legal-statements/open-source-software-statement/>) on Raritan's website.