

PM Series Power Meter

Safety Information

DANGER!

HAZARD OF ELECTRIC SHOCK, EXPLOSION, OR ARC FLASH

Follow safe electrical work practices. See NFPA 70E in the USA, or applicable local codes.

This equipment must only be installed and serviced by qualified electrical personnel.

Read, understand and follow the instructions before installing this product.

Turn off all power supplying equipment before working on or inside the equipment.

Any covers that may be displaced during the installation must be reinstalled before powering the unit.

Use a properly rated voltage sensing device to confirm power is off.

DO NOT DEPEND ON THIS PRODUCT FOR VOLTAGE INDICATION

Failure to follow these instructions will result in death or serious injury.

NOTICE

This product is not intended for life or safety applications.

Do not install this product in hazardous or classified locations.

The installer is responsible for conformance to all applicable codes.

Mount this product inside a suitable fire and electrical enclosure.

CAUTION

RISK OF EQUIPMENT DAMAGE

This product is designed only for use with 0.33V output current transducers (CTs).

DO NOT USE CURRENT OUTPUT (e.g. 5A) CTs ON THIS PRODUCT.

Failure to follow these instructions can result in overheating and permanent equipment damage.

For use in a Pollution Degree 2 or better environment only. A Pollution Degree 2 environment must control conductive pollution and the possibility of condensation or high humidity. Consider the enclosure, the correct use of ventilation, thermal properties of the equipment, and the relationship with the environment. Installation category: CAT II or CAT III

Provide a disconnect device to disconnect the meter from the supply source. Place this device in close proximity to the equipment and within easy reach of the operator, and mark it as the disconnecting device. The disconnecting device shall meet the relevant requirements of IEC 60947-1 and IEC 60947-3 and shall be suitable for the application. Disconnecting fuse holders can be used in the USA and Canada. Provide overcurrent protection and disconnecting device for supply conductors with approved current limiting devices suitable for protecting the wiring.

If the equipment is used in a manner not specified by the manufacturer, the protection provided by the device may be impaired.



This symbol indicates an electrical shock hazard exists.



Documentation must be consulted where this symbol is used on the product.

Equipment Maintenance and Service

WARNING! This equipment must only be installed by qualified electrical personnel. This product contains no user serviceable parts. Do not open, alter or disassemble this product. All repairs and servicing must be performed by Raritan authorized service personnel. Failure to comply with this warning may result in electric shock, personal injury and death.

Raritan

400 Cottontail Lane, Somerset, NJ 08873 USA

Product Overview - PM Series Power Meters

Raritan PM series power meters is a modular power metering solution that is a flexible alternative to the all-in-one BCM2 hardware. All solutions support Xerus technology platform.

The PM series includes controllers, power meters, and branch circuit monitor modules.

In each configuration, you must have exactly one controller component. In the PM series, there are 2 controller options:

1. PMC is a controller-only module.
2. PMMC is a controller with 1 built-in power meter.

PMM: a 3-phase power meter with neutral and earth current monitoring.

PMB: a 96 channel branch circuit monitor that plugs into PMM. A PMM+PMB monitors a panel board mains and branch circuit.

PMC: power meter controller. One PMC controls up to 70 PMM or 8 PMM+PMB. Interconnection uses standard shielded CAT-5 cable. All modules receive redundant power and continue to function as long as one or more PMM remain powered.

PMMC: PMM with a built-in power meter controller. Control up to 69 additional PMM or 8 PMM + PMB.

Raritan PM series power meters are designed for ease of use:

CTs are available in various ratings and contain built-in burden resistors so they can be snapped onto live wires without damage.

CT orientation is not critical because meter auto-corrects polarity for any CT installed backwards.

CT connections are made close to branch circuits using multi-conductor wiring harnesses with individual CT wire-pairs labeled and terminated with a keyed connector.

PMM

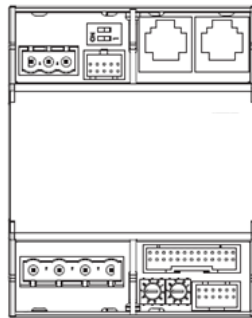

PMC

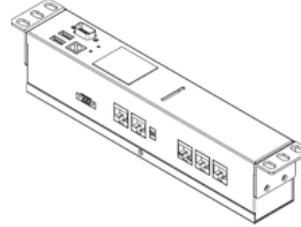

PMB

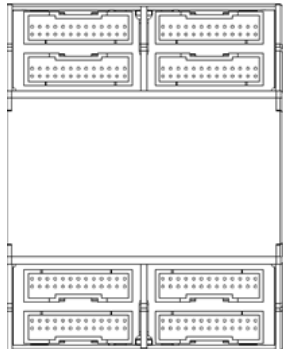

PMMC

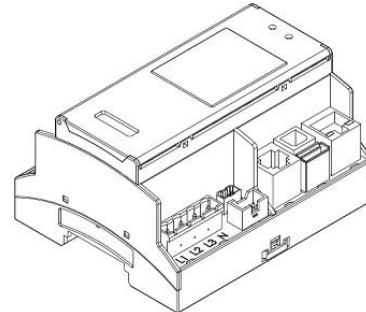

Product Specification

Voltage Measurement Inputs:

Input Range*	90-277VLN, 156-480VLL
Measurement Category	CAT III, Pollution Level 2
Frequency	47-63 Hz
Input Impedance	10MΩ

*Ratings for models with field wiring terminals. For models with factory installed line-cords, rating is limited by plug and ratings are labeled on back on unit.

Current Measurement Inputs:

Input Range	0-333mV
Input Impedance	10kΩ
CT Type	Voltage Output = 333mV at rated current
CT Rated Current	1-1200A

Meter Measurement Accuracy:

Active Power & Energy	0.5%: IEC 62053 Class .5, EN 50470-3 Class C
Reactive Power & Energy	2%
RMS Voltage & Current	0.2%
Frequency	0.1%
Sample Rate	64x AC frequency (phase locked)
Measurement Update Rate	3 seconds: IEC 61000-4-30 Class S

Power Requirements:

Voltage	90-240V
Current	0.2A
Overvoltage Category	CAT III, Pollution Level 2
Frequency	50-60 Hz

Mechanical:

Terminal Block Screw Torque	0.37 ft-lb (0.5Nm) to 0.44 ft-lb (0.6Nm)
Terminal Block Wire Size	14-24AWG (.5-1.6mm)
Terminal Wire Temperature Rating	> 75 degree C
DIN Rail	T35 (35mm)

Environmental:

Operating Temperature	0-60°C
Operating Humidity	5-85%RH
Operating Elevation	0-3000m

Conformance:

Safety	UL/EN 61010-1
EMC/EMI	EN61326-1, FCC Part 15 Class A

Power Meter (PMM) Connectors and Controls

- (A) Voltage Measurement.
- (B) Power
- (C) Factory Use (Do not connect.)
- (D) Meter Bus Terminator Switch
- (E) Meter Bus Connectors. Connects PMM to Controller.
- (F) Factory Use (Do not connect.)
- (G) Multi-conductor Cable CT ABCNE Connector
- (H) Meter ID Configuration Switch

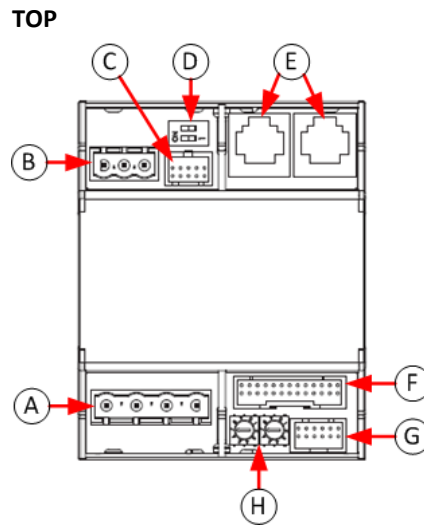

- (I) Expansion Port. Connects PMM to PMB

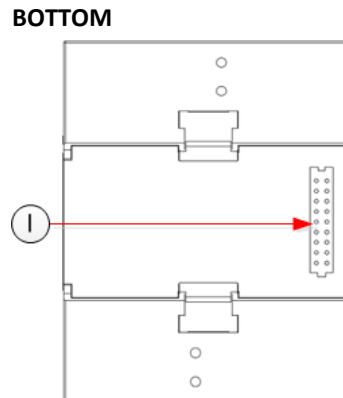

Power Meter Branch Monitor (PMB) Connectors

TOP

- ① Multi-conductor cable CT 1 connector.
- ② Multi-conductor cable CT 2 connector.
- ③ Multi-conductor cable CT 3 connector.
- ④ Multi-conductor cable CT 4 connector.
- ⑤ Multi-conductor cable CT 5 connector.
- ⑥ Multi-conductor cable CT 6 connector.
- ⑦ Multi-conductor cable CT 7 connector.
- ⑧ Multi-conductor cable CT 8 connector.

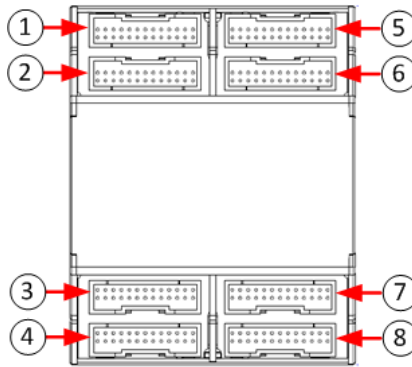

- Ⓐ Expansion port. Connects PMB to PMM or PMMC.

BOTTOM

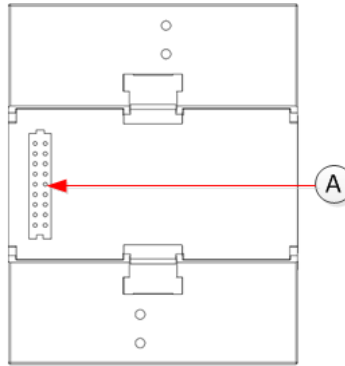

Power Meter with Controller (PMMC)

- Ⓐ Meter Bus Connectors
- Ⓑ Meter Bus Terminator Switch
- Ⓒ Meter ID Configuration Switch
- Ⓓ Power
- Ⓔ Ethernet
- Ⓕ USB-A and USB-B
- Ⓖ Sensor Port
- Ⓗ Multi-conductor Cable CT ABCNE Connector
- Ⓘ Modbus

TOP

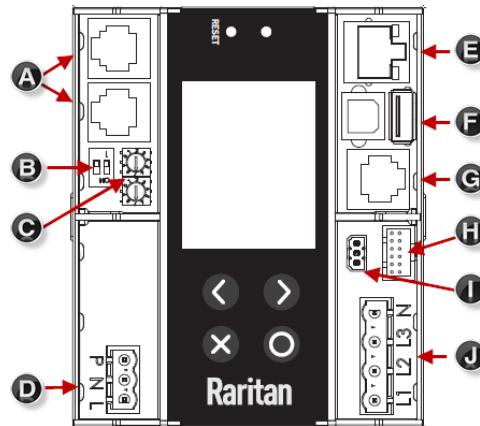

END

J Voltage Measurement

Expansion Port is on bottom side of unit.
Connects PMMC to PMB.

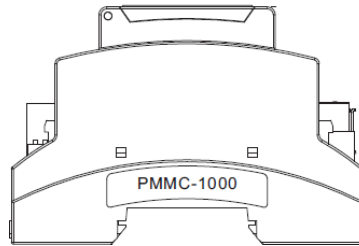

Power Meter Controller (PMC) iX6/iX7

- A** MODBUS RTU isolated RS-485
- B** Meter bus connector (to PMM)
- C** Meter bus terminator switch
- D** 10/100 base-t Ethernet.
- E** Feature port (Raritan asset strip)
- F** Sensor port (temperature, humidity, etc.)
- G** USB A & B (flash drives, WIFI, serial port)
- H** RS-232 (terminal CLI, modem)
- I** Pin-hole access reset button
- J** LCD (meter readings, settings, configuration)
- K** Keypad

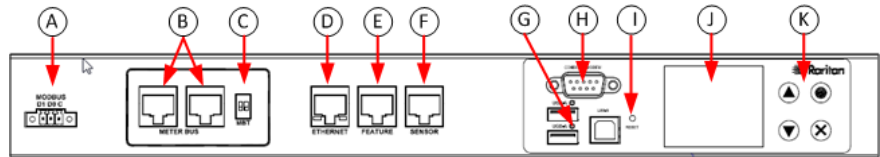

Note: iX7 PMC and BCM2 devices have RJ45 console connectors. iX6 has a DE-9 console connector.

DIN Rail Mounting PMM + PMB

- A** Expansion Connector supplied with PMB.



Do not hot-plug the Expansion Port! PMM and PMB must be disconnected from all power source before plugging Expansion Port.

Snap Expansion Connector to Expansion Ports on bottoms of PMM and PMB or PMMC and PMB.

*Example shows PMC model.

BOTTOM

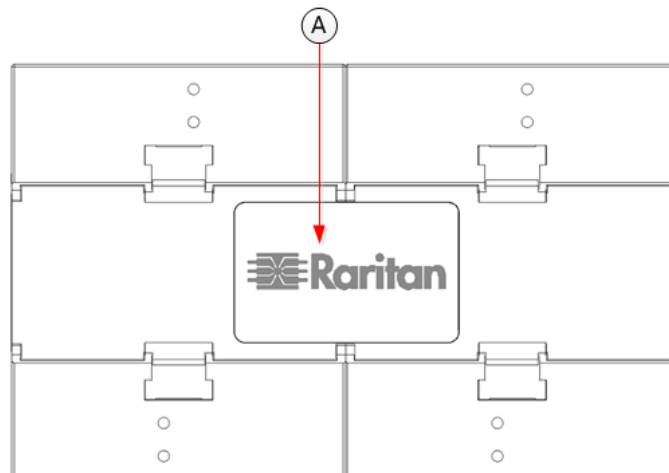

- (B) 35mm DIN rail
- (C) PMM
- (D) PMB
- (E) Modules snap into rail. Pull white tab here to remove.

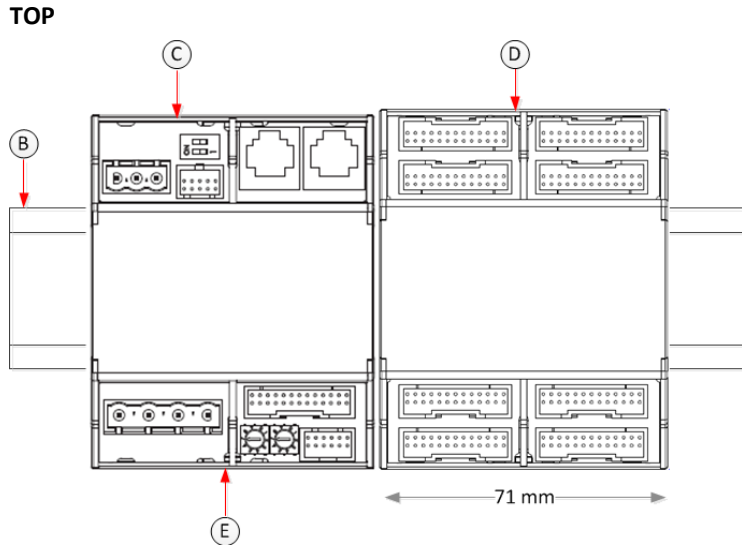

Voltage and Current Measurement Wiring

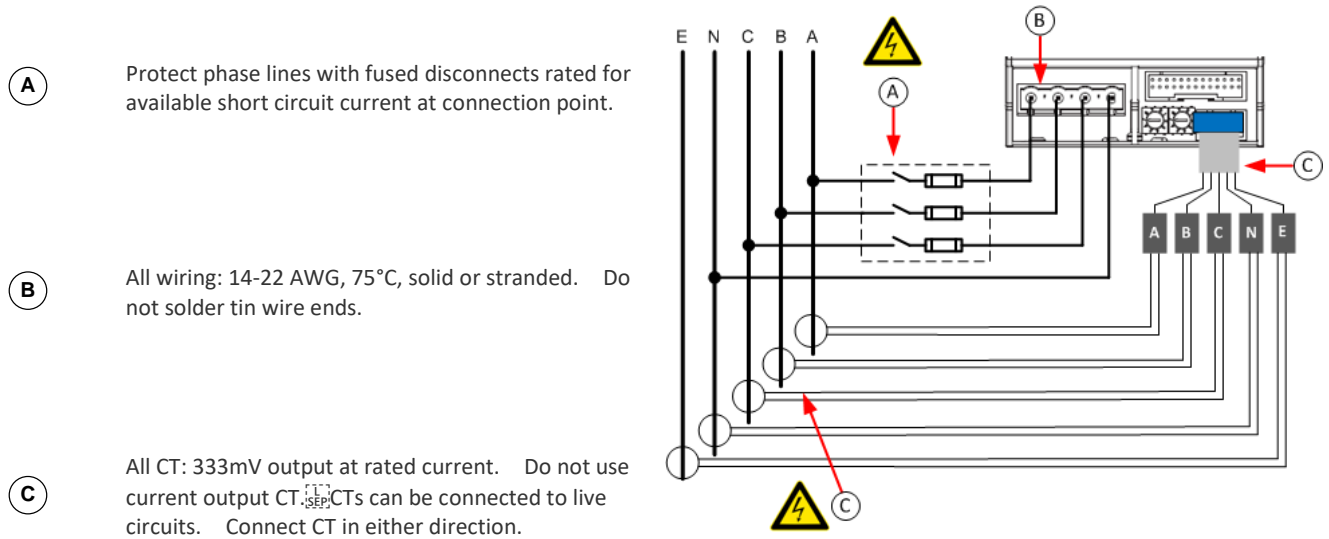

Circuit Type	Circuit Description	Wiring Connections						
		Voltage				CT		
		A	B	C	N	A	B	C
Single-Phase	L-N (120V, 230V, 240V)	X			X	X		
	L-L (208V, 400V)	X	X			X		

Split-Phase	North American 120/240V Panel, 2L+N circuit	X	X		X	X	X	
Three-Phase	3L, 3-phase without neutral	X	X	X		X	X	X
	3L+N, 3-phase with neutral	X	X	X	X	X	X	X

Note: X: Selection, Blank: Non-selection

PMB Branch Circuit Wiring

A CT plugs into 2-pin locking connector (Molex 43640-0201)

B Branch Circuits have two labels: Red labels for odd/even numbered panels. White labels for sequentially numbered panels.

C Multi-conductor CT cable. Available lengths: 3m, 10m.

D Connect labeled end into matching labeled connector

All CTs 333mV output. DO NOT use current output CT.

CT can be connected to live circuit in either direction. Meter auto corrects polarity.

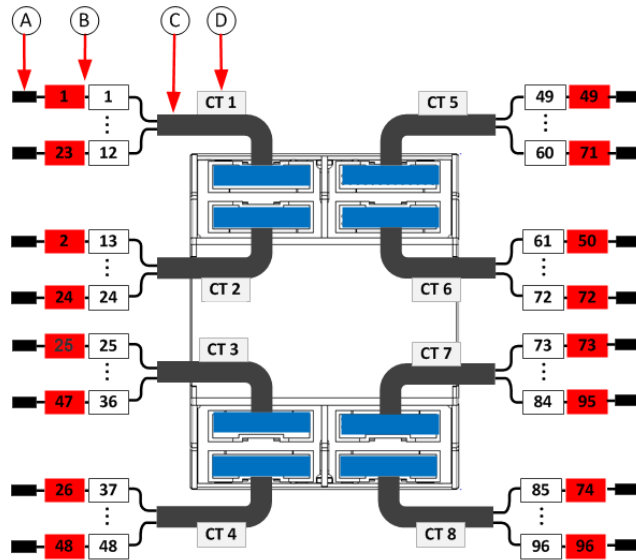
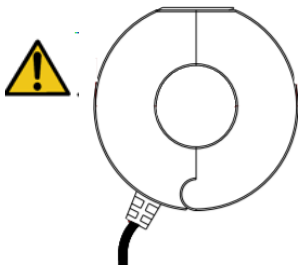

Branch Circuit	Description	Current Transformers	
		How Many	Connect To
Line-Neutral (LN)	120V/230V circuit wired to 1-pole circuit breaker	1	phase line
Line-Line (LL)	208/240/400V circuit wired to 2-pole circuit breaker	1	either phase line
Line-Line-Neutral (LLN)	120V+208/240V circuit wired to 2-pole circuit breaker	2	each phase line
Three-Phase (LLL, LLLN)	3-phase circuit wired to 3-pole circuit breaker	3	each phase line

PMM Power Wiring

PMM can be powered from the voltage measurement inputs or from an auxiliary AC power source. Powering from the voltage measurement inputs minimizes circuitry, but the meter may stop functioning if the voltage turns off.

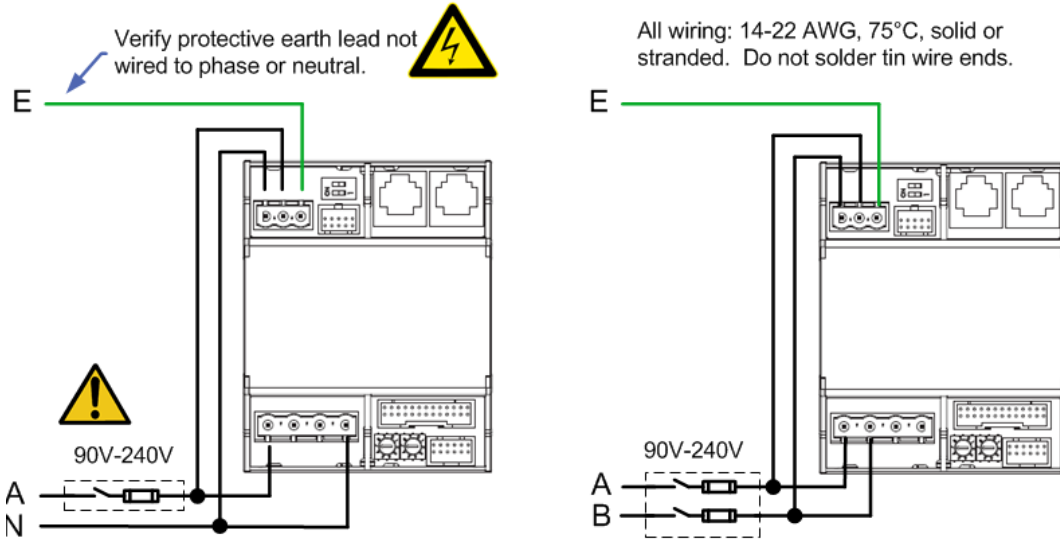

Powering from an auxiliary single phase circuit is required when the voltage measurement circuit exceeds 240V, or when continued operation is required if the voltage measurement inputs turn off.

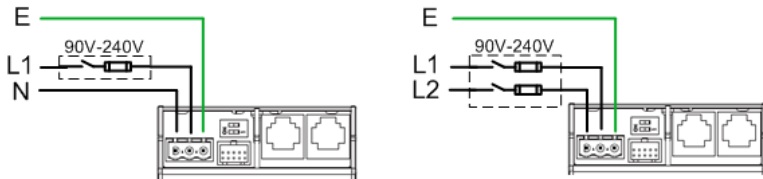

PMMC Power Wiring

PMMC can be powered from the voltage measurement inputs or from an auxiliary AC power source. Powering from the voltage measurement inputs minimizes circuitry, but the meter may stop functioning if the voltage turns off.

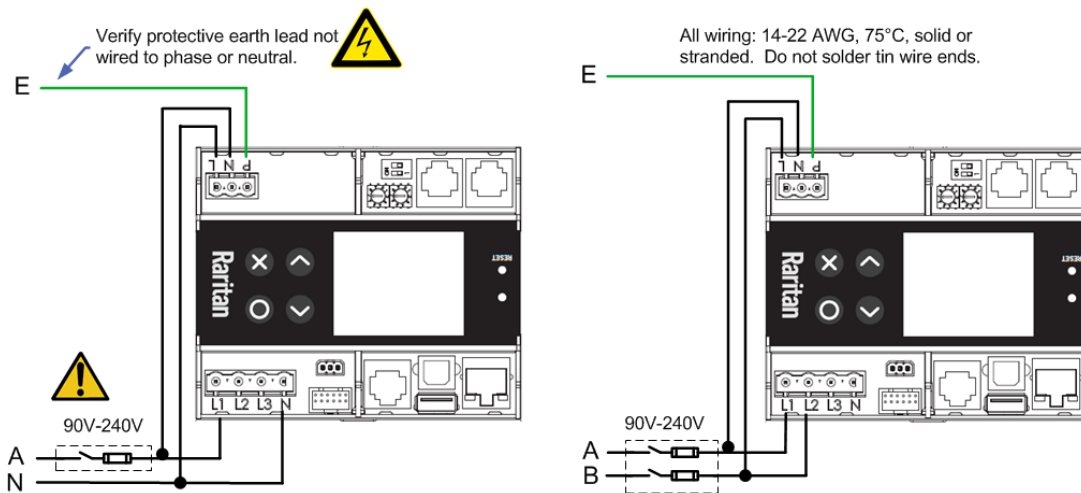

Powering from an auxiliary single phase circuit is required when the voltage measurement circuit exceeds 240V, or when continued operation is required if the voltage measurement inputs turn off.

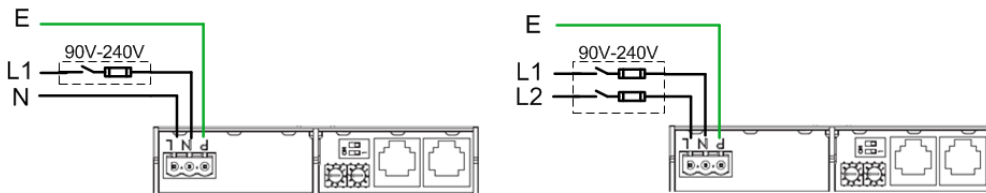

Controller Wiring to Meters

The PMC controller supports up to 70 power meters (PMM) **OR** eight branch circuit meters (PMM+PMB) using daisy-chain wiring with shielded cat 5 Ethernet cable. The wiring order of the modules and controller is not important.

The PMMC controller supports 69 additional power meters (PMM), **OR** 7 additional branch circuit meters (PMM+PMB).

Note: Diagram shows PMC model. Wiring is the same for PMMC model, except that the first PMM is built into the PMMC.

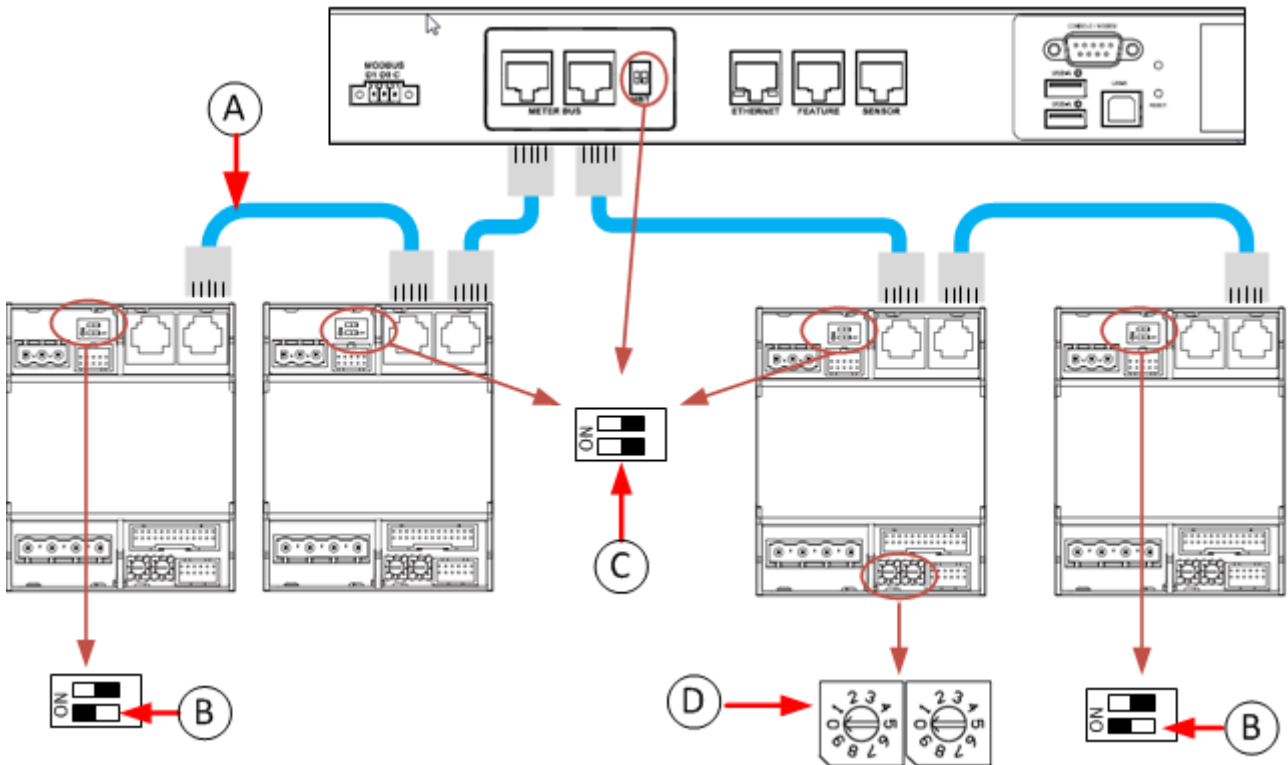

- (A) All cables shielded Cat-5, each cable:100m max. length.
- (B) Switch MBT (terminator) ON for devices at ends of daisy chain.
- (C) Switch MBT OFF for devices in middle of daisy chain.
- (D) Assign each meter unique ID:
01-70: PMM without PMB
01-08: PMM with PMB

Panel Layout

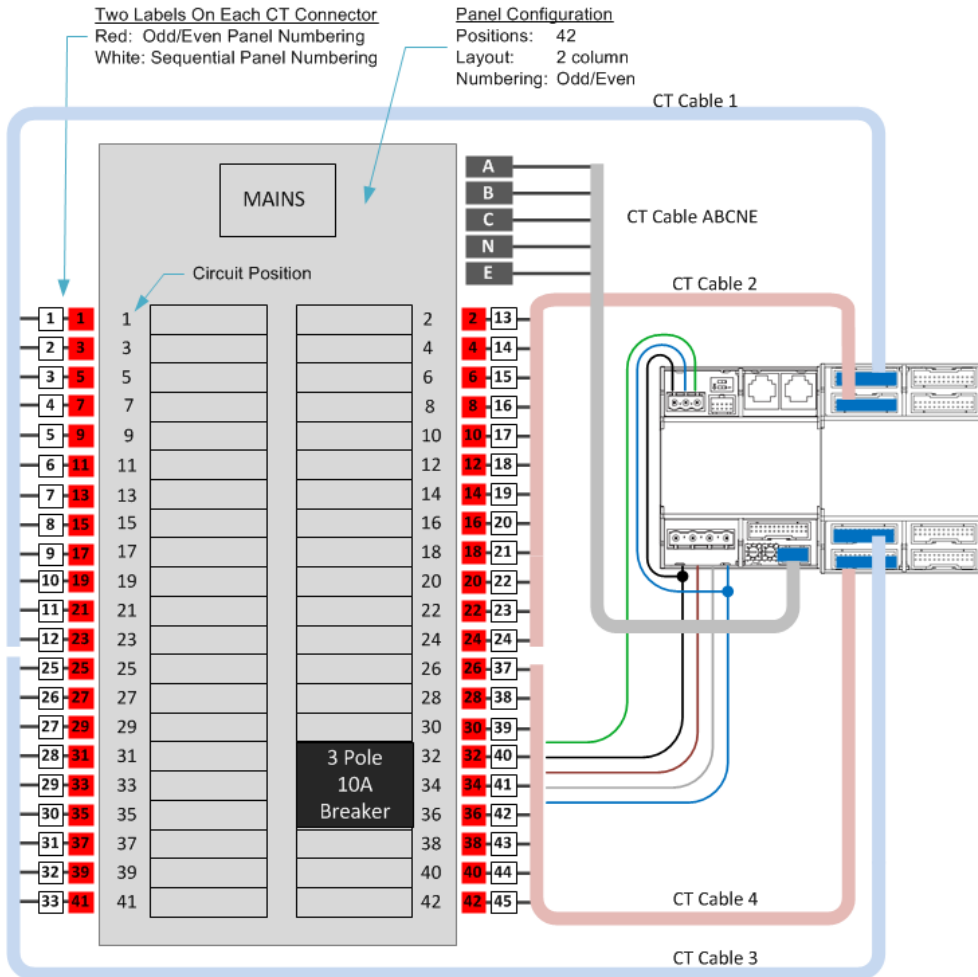

Login and Configuration

Connect your PC directly to the PM-Series Power Meter/Branch Circuit Monitor to complete the initial configuration.

► To access the web interface at the rack:

1. Disable the wireless interface of the PC.
2. Connect a cat 5 cable between the PC and PM-Series Power Meter/Branch Circuit Monitor network ports.
3. Open a browser. Enter the URL "https://pdu.local". The login page appears.

If the URL does not resolve, use the IP address of the PMC. Retrieve the direct IP address using the LCD display: Menu > Device Information, scroll to the IPV4 settings. Enter the IP address in the web browser: "https://IP address/"

4. Login with the default username and password. Allow 30 seconds for first connection. Password change is forced upon first login.
 - Username: admin
 - Password: raritan

Configuring Power Meters and Branch Circuit Monitors

You can configure your product with a spreadsheet, or in the product's web interface.

► To configure with a spreadsheet:

Go to Raritan.com and download the configuration spreadsheet from the BCM2 Support page. Follow the instructions in the spreadsheet.

► **To configure with the product web interface:**

Make a network connection to the product. See **Login and Configuration** (on page 11). Follow the instructions in this guide, starting with: Scan Power Meters.

Configure Using the Web Interface

Scan Power Meters

- ① Click Power Meters.
- ② If nothing is configured, scan begins immediately in the Unconfigured Meters section. Click Rescan to refresh the list.
- ③ Click the power meter or panel in the discovered list to configure it.
Types:
PM: 3-phase
Panel: BCM

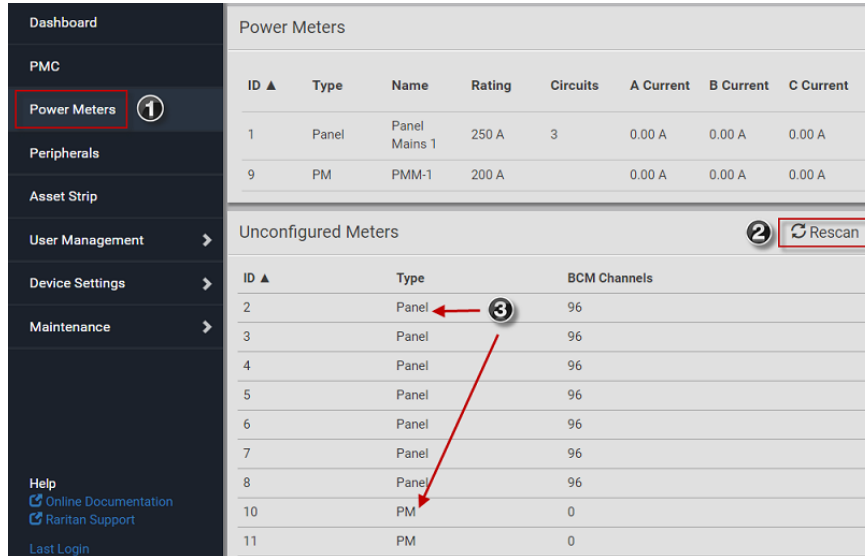

The screenshot shows the 'Power Meters' web interface. On the left is a dark sidebar with a menu where 'Power Meters' is highlighted with a circled '1'. The main content area is divided into two sections. The top section, 'Power Meters', contains a table with columns: ID ▲, Type, Name, Rating, Circuits, A Current, B Current, and C Current. It lists two items: ID 1 (Panel, Panel Mains 1, 250 A, 3 Circuits) and ID 9 (PM, PMM-1, 200 A). The bottom section, 'Unconfigured Meters', has a 'Rescan' button with a circled '2' and a refresh icon. Below it is a table with columns: ID ▲, Type, and BCM Channels. It lists items with IDs 2 through 11. A red arrow points from a circled '3' to the 'Type' column of item ID 2, and another red arrow points from the same circled '3' to the 'Type' column of item ID 10.

Configure Power Meter (PMM without PMB)

- ① Enter a name.
Select the circuit type:
 - ② Single Phase
Split Phase
3-phase
 - ③ Enter the mains circuit breaker rating.
 - ④ Select the checkbox for each CT installed.
Enter the CT rating. Ratings are marked on the CT.
 - ⑤ Click OK.
- The configured power meter displays in the dashboard and Power Meters page.

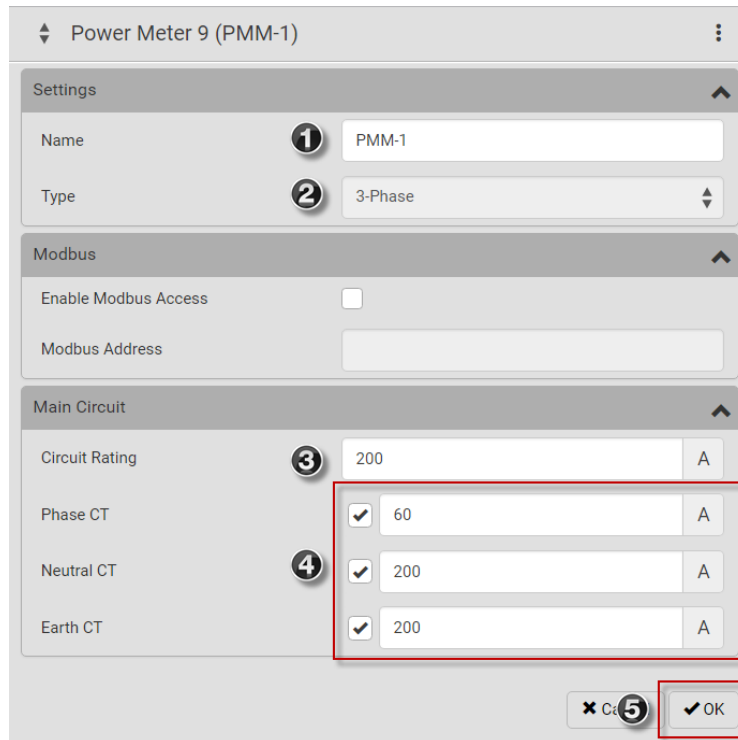

The screenshot shows the configuration page for 'Power Meter 9 (PMM-1)'. The page is divided into three sections: Settings, Modbus, and Main Circuit. In the Settings section, the 'Name' field contains 'PMM-1' (callout 1) and the 'Type' dropdown is set to '3-Phase' (callout 2). In the Main Circuit section, the 'Circuit Rating' is set to '200' (callout 3). Below it, three rows for 'Phase CT', 'Neutral CT', and 'Earth CT' each have a checked checkbox and a rating of '200' (callout 4). At the bottom right, there is a 'Cancel' button with a circled '5' and an 'OK' button (callout 5).

Configure Panel Mains Circuit

- 1 Enter a name.
Select the circuit type:
- 2 Single Phase
Split Phase
3-phase
- 3 Enter the number of circuit positions in the panel.
Select the panel layout: one or two columns.
Select the circuit position numbering style: sequential or odd/even.
- 4 Enter the current rating (circuit breaker rating) of the circuit.
Select the checkbox for each CT installed.
- 5 Enter the CT rating. Ratings are marked on the CT.
- 6 Click OK.

Configuration Panel 1

Settings

Name **1**

Type **2**

Panel Layout

Number of Circuit Positions

Panel Layout **3**

Circuit Position Numbering

Modbus

Enable Modbus Access

Modbus Address

Main Circuit

Circuit Rating **4** A

Phase CT A

Neutral CT **5** A

Earth CT A

6

Configure Panel Branch Circuits

- 1 In the Power Meters page, click the panel.

The Panel details page opens.
- 2 In the Panel Branch Circuits section, click the circuit position to open the pop-up menu.

Dashboard		Power Meters			
PM	Power Meters	ID ▲	Type	Name	Rating
1	1	1	Panel	Panel Mains 1	250 A
		9	PM	PMM-1	200 A

Panel Branch Circuits											
Pos	Phase	Name	Rating	CT #	V	A	φ	Pos	Phase	Name	Rating
1	A							2	A		
3	B							4	B		
5	C							6	C		
7	A							8	A		

2 ←

3 + Create Circuit

3 Click Create Circuit. The Create Circuit dialog opens.

4 Enter a name for the circuit.

5 Select the circuit type: One-Phase LN, One-Phase LL, One-Phase LLN, or Three-Phase. Circuit type cannot be changed later.

6 Enter the current rating of the circuit in Amps.

7 Enter the rating of the CT connected at this circuit position in Amps.

8 Click the Phase or CT# to edit the automatic labels.

9 Click Create.

Circuits appear in the list with a black bracket around the circuit positions.

Panel Branch Circuits						
Pos	Phase	Name	Rating	CT #	V	
1	A	Rack 1	20 A	1	0.0 V	}
3	B			3		
5	C			5		
7	A	Rack 3	20 A	7	0.0 V	}
9	B			9		
11	C			11		

Configure Thresholds

1 In the Power Meters page, click the panel or power meter.

The details page opens.

- 2 In the details page, click the actions icon, then choose Edit Thresholds.

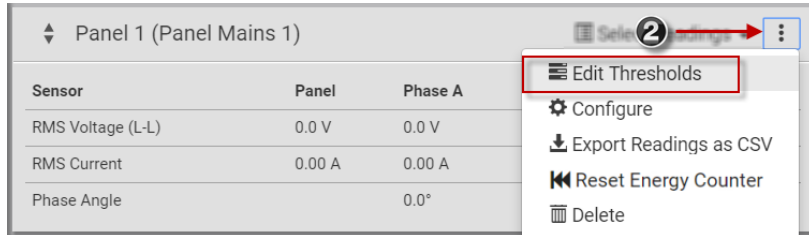

- 3 The sensor list displays. Click a sensor to open the Edit Threshold dialog.

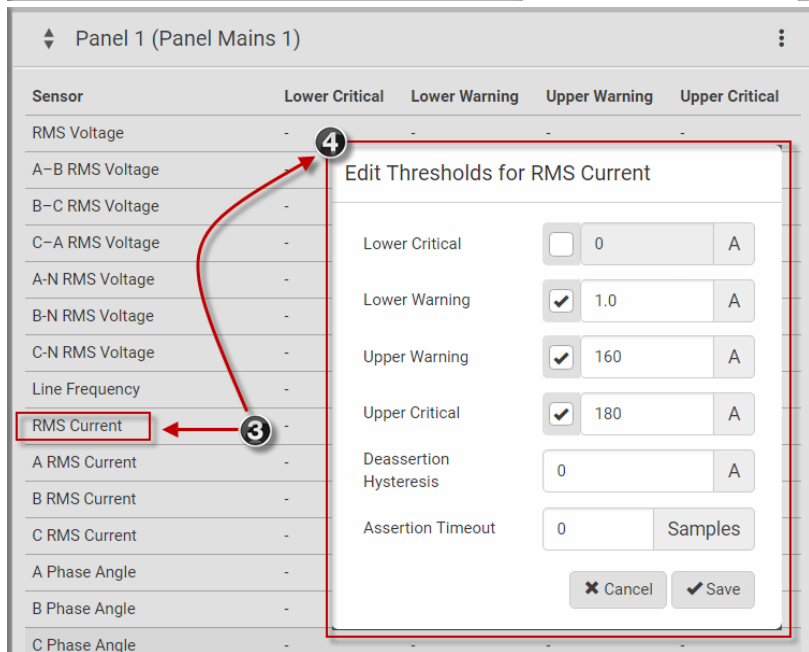

Select the checkbox for the level, and enter the threshold current in amps. Click OK.

- 4 This example shows RMS Current thresholds set for upper warning and critical levels for the circuit max current rating, and a lower warning set for 1 amp.

Using the PM-Series Power Meter/Branch Circuit Monitor's Display

▶ Automatic Mode:

The PM-Series Power Meter/Branch Circuit Monitor has a display with automatic and manual modes. In automatic mode, the display scrolls through readings.

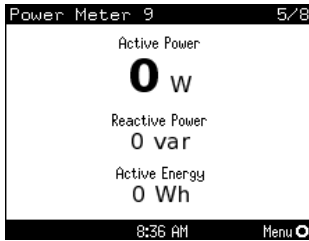



▶ Manual Mode:

In manual mode, you can select readings and settings to view.

Press  or  to view the Main Menu.

To return to automatic mode, press  once or several times.

Press   to choose a menu item. Press  to select.

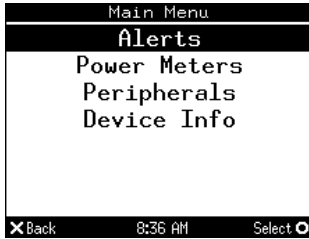

▶ Power Meters list

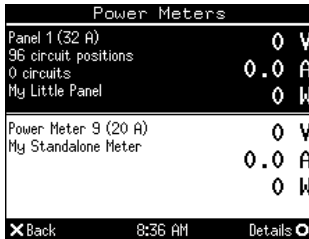

▶ Power Meter details

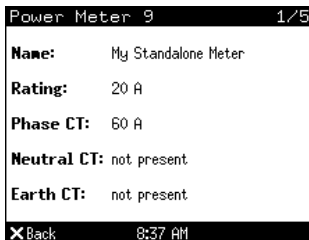

Appendix A: Configuration via a Mobile Device or PDView

An iOS or Android mobile device, such as a smartphone or tablet, can function as a local display. Android devices must support USB "On-The-Go" (OTG).

Step 1: Download the "PDView" App

Raritan's free app "PDView" is required for the mobile device to function as a local display.

▶ To download PDView:

1. Visit either Apple App or Google Play Store.

- <https://itunes.apple.com/app/raritan-pdview/id780382738>



- <https://play.google.com/store/apps/details?id=com.raritan.android.pdview>



2. Install PDView.



Step 2: Connect the Mobile Device to PM-Series Power Meter/Branch Circuit Monitor

The USB cable and USB port to connect are determined by your mobile operating system.

► To connect your mobile device to PM-Series Power Meter/Branch Circuit Monitor:

1. Get an appropriate USB cable for your mobile device.
 - *iOS*: Use the regular USB cable shipped with your iOS mobile device.
 - *Android*: Use an **USB OTG** adapter cable.
2. Connect the mobile device to the appropriate USB port on the product.
 - *iOS*: USB-A port.
 - *Android*: USB-B port

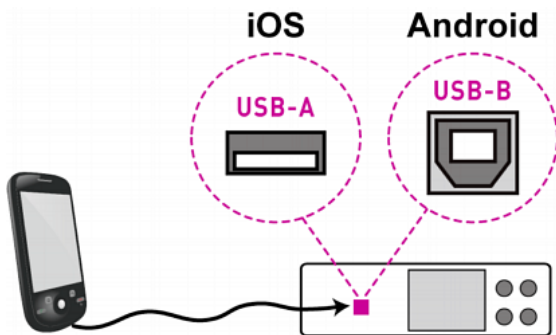

Step 3: Launch PDView

► To access the PM-Series Power Meter/Branch Circuit Monitor web interface:

1. Launch PDView on your mobile device.
2. Wait until PDView detects the connected PM-Series Power Meter/Branch Circuit Monitor and shows the word "Connected" in green.

Connected

3. If the factory-default login credentials remain unchanged, or if PDView has been configured with accurate login credentials, PDView automatically logs in to the web interface of PM-Series Power Meter/Branch Circuit Monitor.
If PDView can't login automatically, the login screen displays instead and you must enter appropriate user credentials for login.
4. For initial login, you are prompted to change the password.